

Elaborato
allegato

D

ALLEGATI DESCRITTIVI E RELAZIONALI ABACO DEGLI ELEMENTI ARCHITETTONICI

Progettista
ARCH. GIOVANNANGELA FLORIS

Gruppo di Lavoro
ARCH. GIULIANO COSSEDDU
ARCH. VALENTINA ISONI
ING. RAIMONDO PINNA

Progettazione Ufficio del Piano
ARCH. BALDASSARRE RIU
DOTT. ALFREDO CURCURUTO
DOTT. ANGELO R. MANUNTA
GEOM. FRANCO CHERCHI

Dirigente Settore Urbanistica
GUIDO CALZIA

Assessore all'Urbanistica
ING. ALESSANDRO BALZANI

Sindaco
MARIO BRUNO

Data
APRILE 2018

Scala
-

Adozione C.C. N.

del

Approvazione Def. C.C. N.

del

Det. Ass. Reg. Urb. N.

del

Pubb. BURAS N.

del



1 - BASAMENTO_ZOCCOLATURA



1 - BASAMENTO_ZOCCOLATURA

INQUADRAMENTO PLANIMETRICO

PIANO PARTICOLAREGGIATO DEL CENTRO DI ANTICA E PRIMA FORMAZIONE DI ALGHERO E FERTILIA

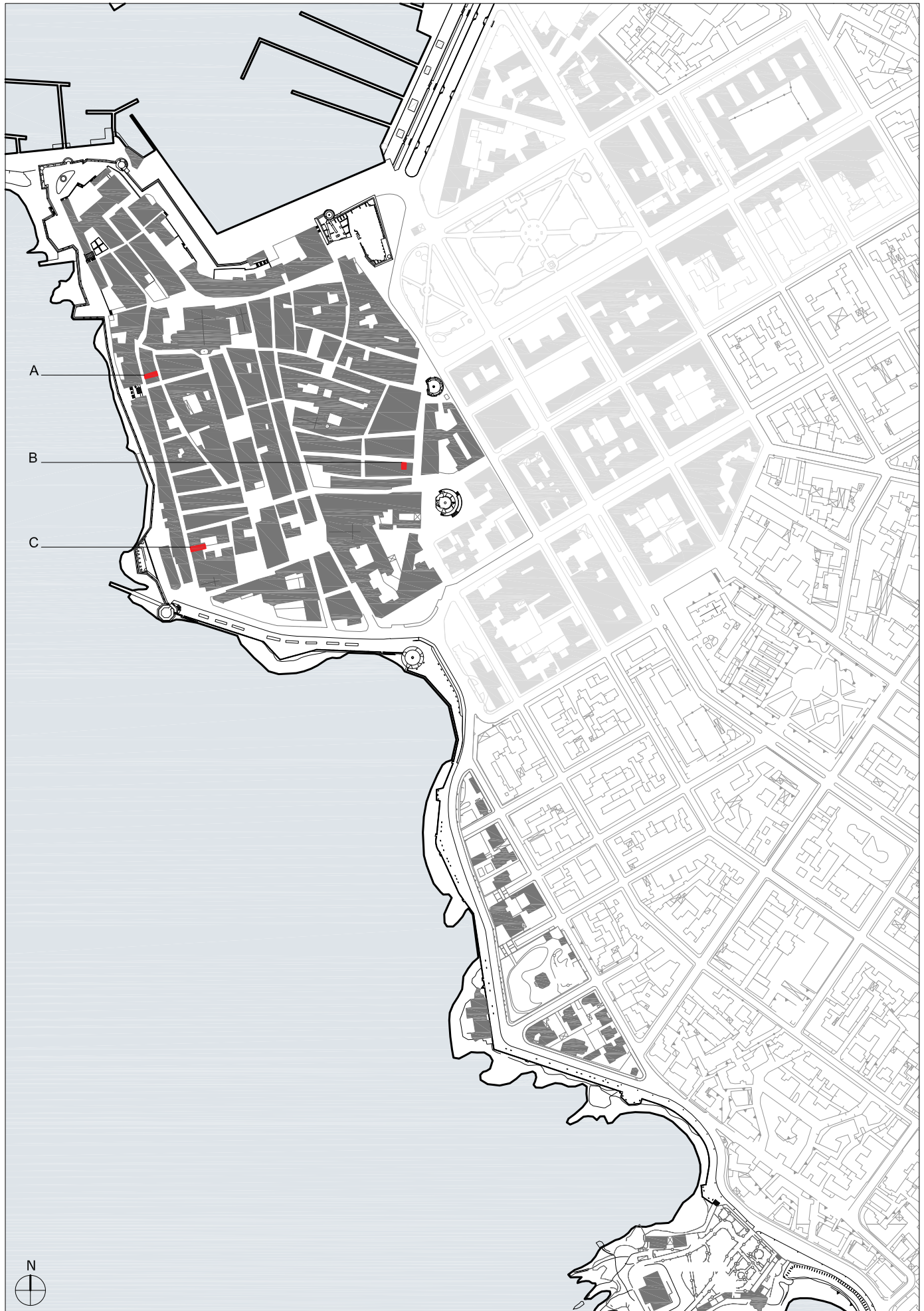



1 - BASAMENTO_ZOCCOLATURA

INQUADRAMENTO PLANIMETRICO

PIANO PARTICOLAREGGIATO DEL CENTRO DI ANTICA E PRIMA FORMAZIONE DI ALGHERO E FERTILIA



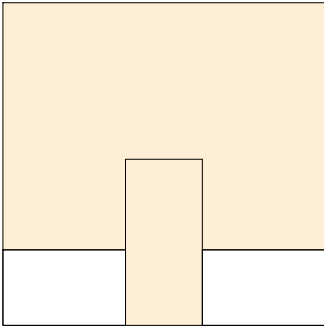

UE 1806



TIPO 1A)
NON IN RILIEVO, CON FINITURA
SUPERFICIALE AD INTONACO RUSTICO O
SOLA TINTEGGIATURA

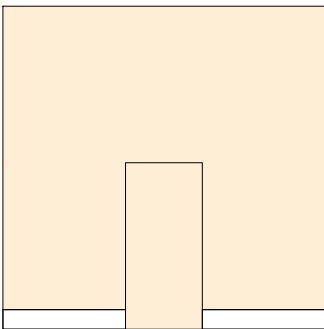

UE 3510



TIPO 1B)
IN RILIEVO SEMPLICE O ARTICOLATA CON
FINITURA SUPERFICIALE AD INTONACO E
TINTEGGIATURA

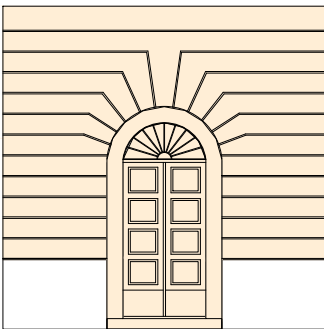

UE 5111



TIPO 1C)
RACCORDATA AL PARAMENTO BUGNATO

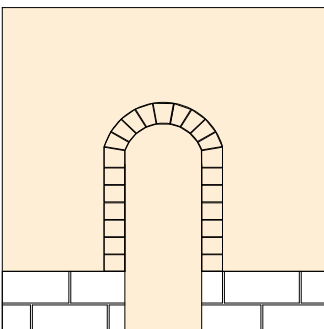

UE 8101



TIPO 1D)
IN PIETRA A VISTA



2 - CORNICI PORTONI



2 - CORNICI PORTONI

INQUADRAMENTO PLANIMETRICO

PIANO PARTICOLAREGGIATO DEL CENTRO DI ANTICA E PRIMA FORMAZIONE DI ALGHERO E FERTILIA





2 - CORNICI PORTONI

INQUADRAMENTO PLANIMETRICO

PIANO PARTICOLAREGGIATO DEL CENTRO DI ANTICA E PRIMA FORMAZIONE DI ALGHERO E FERTILIA



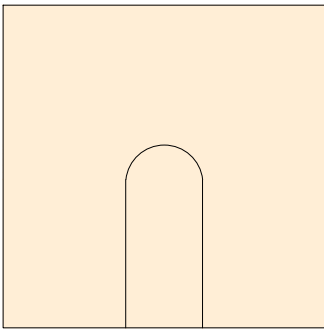

UE 5310



TIPO 2A)
SENZA CORNICI EVIDENTI

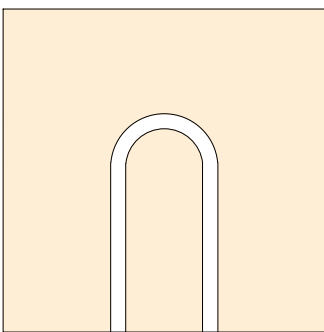

UE 5702



TIPO 2B) NON IN RILIEVO, CON FINITURA
SUPERFICIALE AD INTONACO O SOLA
TINTEGGIATURA

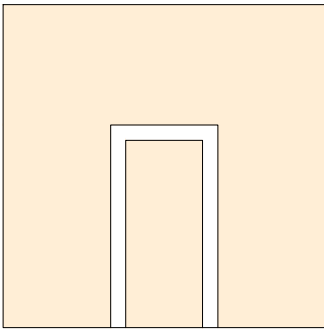

UE 4410



TIPO 2C)
IN RILIEVO, SEMPLICE O ARTICOLATA CON
FINITURA SUPERFICIALE AD INTONACO E
TINTEGGIATURA

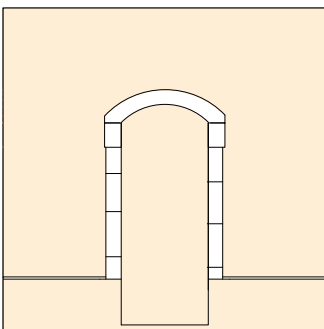

UE 8306



TIPO 2D)
IN PIETRA A VSITA

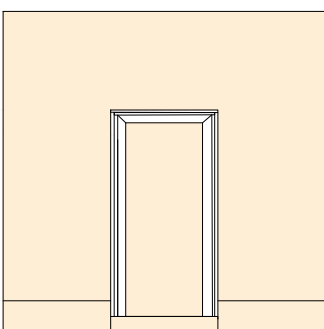

UE 7306



TIPO 2E)
CON RIVESTIMENTO IN LASTRE



3 - PORTONI



3 - PORTONI

INQUADRAMENTO PLANIMETRICO





3 - PORTONI

INQUADRAMENTO PLANIMETRICO

PIANO PARTICOLAREGGIATO DEL CENTRO DI ANTICA E PRIMA FORMAZIONE DI ALGHERO E FERTILIA





3 - PORTONI

INQUADRAMENTO PLANIMETRICO



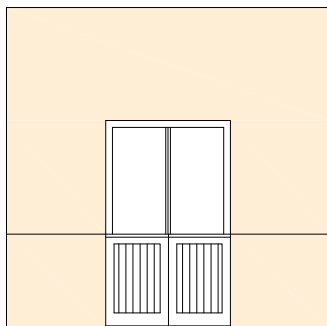

UE 2619



TIPO 3A)
CON "PORTALLETA"

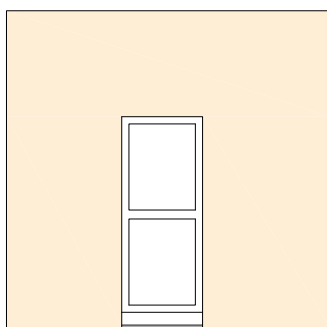

UE 1514



TIPO 3B)
AD UN'ANTA CON BUGNE SEMPLICI O
IN RILIEVO

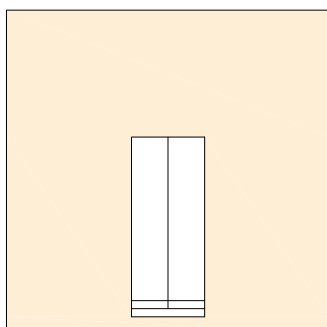

UE 5113



TIPO 3C)
A DUE ANTE LISCIA

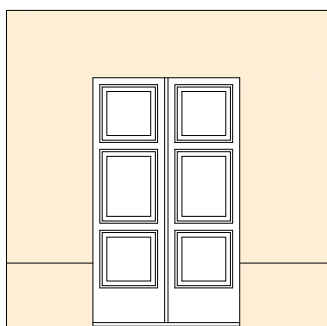

UE 1807



TIPO 3D)
A DUE ANTE CON BUGNE SEMPLICI O IN RILIEVO

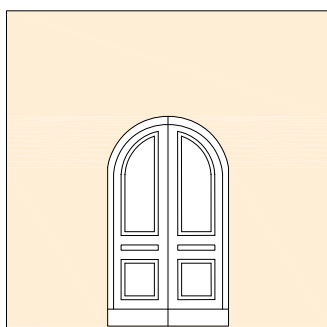

UE 7012



TIPO 3E)
A DUE ANTE CON BUGNE SEMPLICI O A
RILIEVO E ARCO A TUTTO SESTO

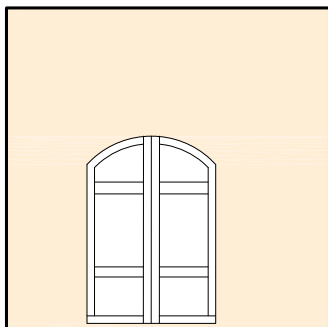

UE 2805



TIPO 3F)
A DUE ANTE CON BUGNE SEMPLICI O A
RILIEVO E ARCO RIBASSATO

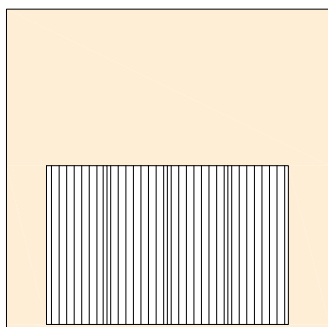

UE 2612



TIPO 3G)
A DUE O PIU' ANTE CON DOGHE VERTICALI

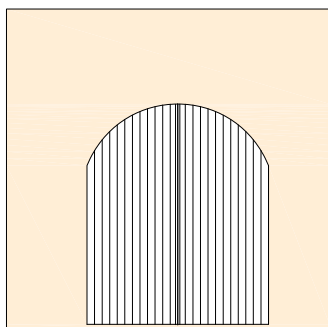

UE 5204



TIPO 3H)
A DUE O PIU' ANTE A DOGHE VERTICALI
ED ARCO A TUTTO SESTO

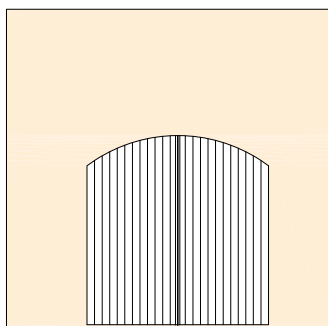

UE 101



TIPO 3I)
A DUE O PIU' ANTE A DOGHE VERTICALI
ED ARCO RIBASSATO

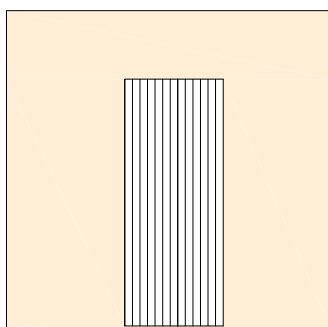

UE 2103



TIPO 3L)
A UNA O DUE ANTE A DOGHE VERTICALI

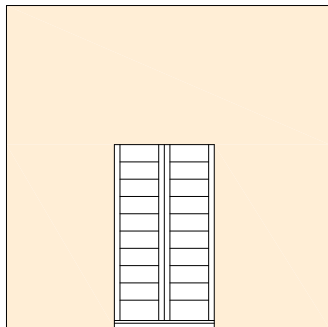

UE 2902



TIPO 3M)
A UNA O DUE ANTE A DOGHE ORIZZONTALI

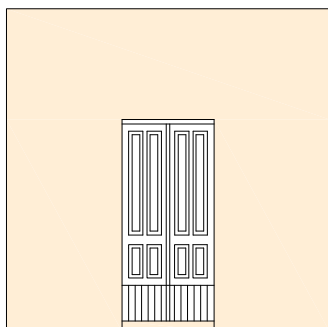

UE 8609



TIPO 3N)
A DUE ANTE CON COPPIE DI BUGNE
UGUALI RETTANGOLARI

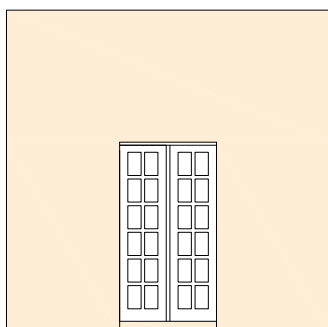

UE 8504



TIPO 3O)
A DUE ANTE CON PIU' BUGNE
RETTANGOLARI IN RILIEVO

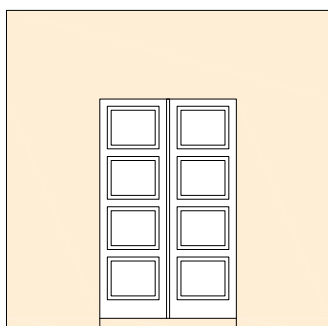

UE 10701



TIPO 3P)
A DUE ANTE CON QUATTRO BUGNE
IN RILIEVO



4 - SOPRALUCE



4 - SOPRALUCE

INQUADRAMENTO PLANIMETRICO

PIANO PARTICOLAREGGIATO DEL CENTRO DI ANTICA E PRIMA FORMAZIONE DI ALGHERO E FERTILIA

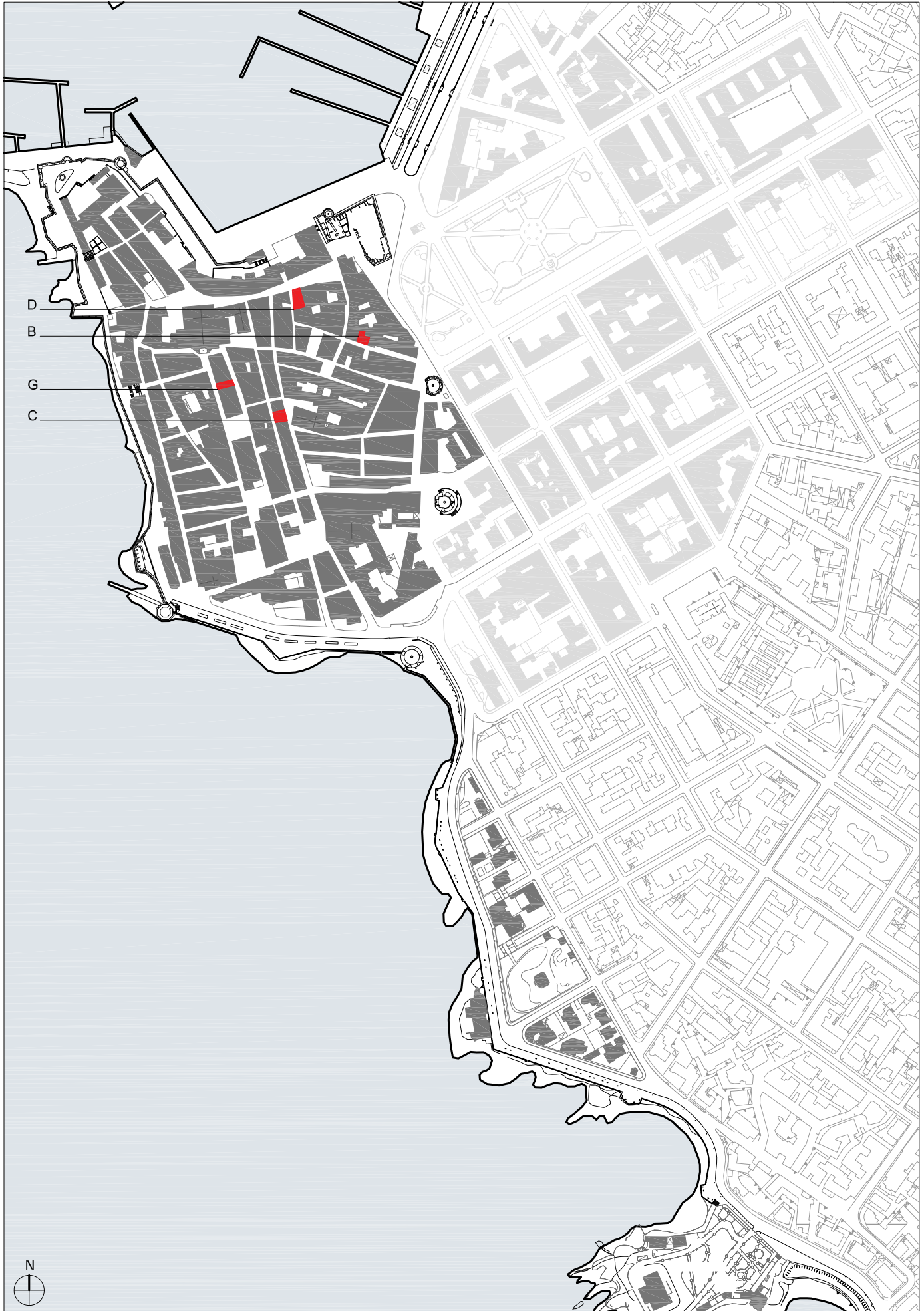



4 - SOPRALUCE

INQUADRAMENTO PLANIMETRICO

PIANO PARTICOLAREGGIATO DEL CENTRO DI ANTICA E PRIMA FORMAZIONE DI ALGHERO E FERTILIA



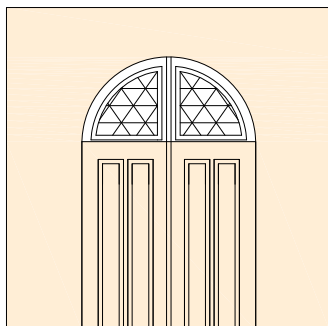

UE 7012



TIPO 4A)
INTEGRATO NEL
PORTONE AD ARCO

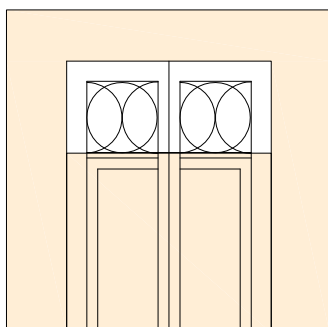

UE 4410



TIPO 4B)
INTEGRATO NEL
PORTONE RETTANGOLARE

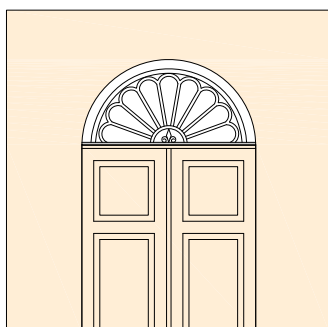

UE 3102



TIPO 4C)
AD ARCO A TUTTO SESTO

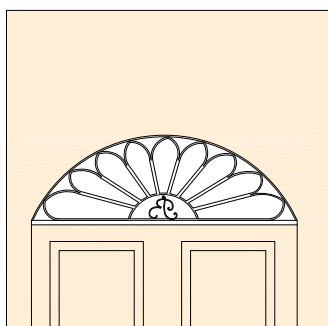

UE 4109



TIPO 4D)
AD ARCO RIBASSATO

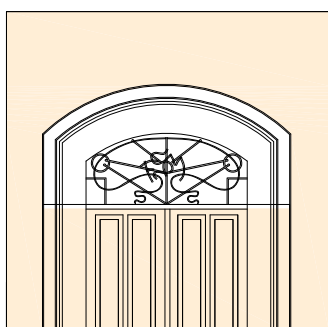

UE 8502



TIPO 4E)
RETTANGOLARE CON
ARCO RIBASSATO

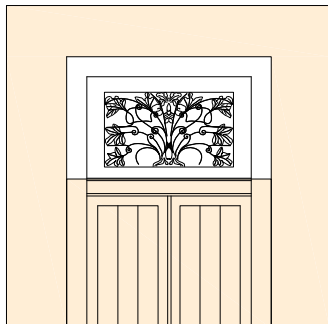

UE 7911



TIPO 4F)
RETTANGOLARE

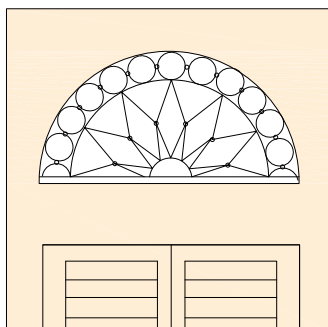

UE 2206



TIPO 4G)
SEPARATO DAL PORTONE



5 - CORNICI MARCAPIANO



5 - CORNICI MARCAPIANO

INQUADRAMENTO PLANIMETRICO

PIANO PARTICOLAREGGIATO DEL CENTRO DI ANTICA E PRIMA FORMAZIONE DI ALGHERO E FERTILIA





5 - CORNICI MARCAPIANO

INQUADRAMENTO PLANIMETRICO

PIANO PARTICOLAREGGIATO DEL CENTRO DI ANTICA E PRIMA FORMAZIONE DI ALGHERO E FERTILIA



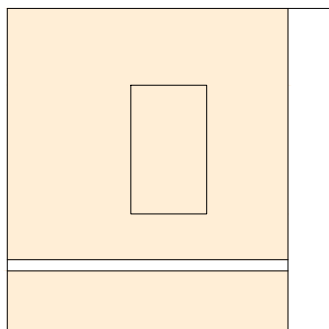

UE 3407



TIPO 5A)
NON IN RILIEVO CON FINITURA
SUPERFICIALE AD INTONACO
LISCIO/RUSTICO O SOLA
TINTEGGIATURA

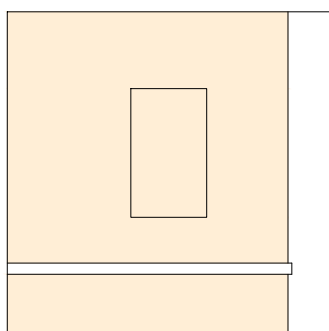

UE 909



TIPO 5B)
IN RILIEVO SEMPLICE
CON FINITURA SUPERFICIALE AD
INTONACO E TINTEGGIATURA

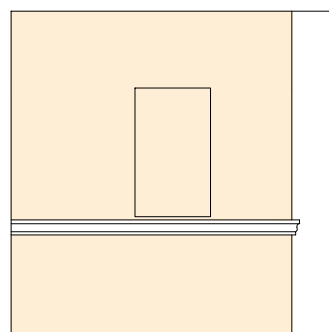

UE 7705



TIPO 5C)
IN RILIEVO MODANATA
CON FINITURA SUPERFICIALE AD
INTONACO E TINTEGGIATURA

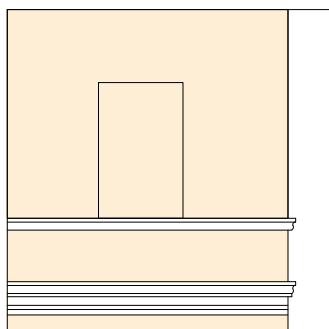

UE 707



TIPO 5D)
IN RILIEVO CON DOPPIA MODANATURA
CON FINITURA SUPERFICIALE E
TINTEGGIATURA



6 - CORNICI FINESTRE



6 - CORNICI FINESTRE

INQUADRAMENTO PLANIMETRICO

PIANO PARTICOLAREGGIATO DEL CENTRO DI ANTICA E PRIMA FORMAZIONE DI ALGHERO E FERTILIA

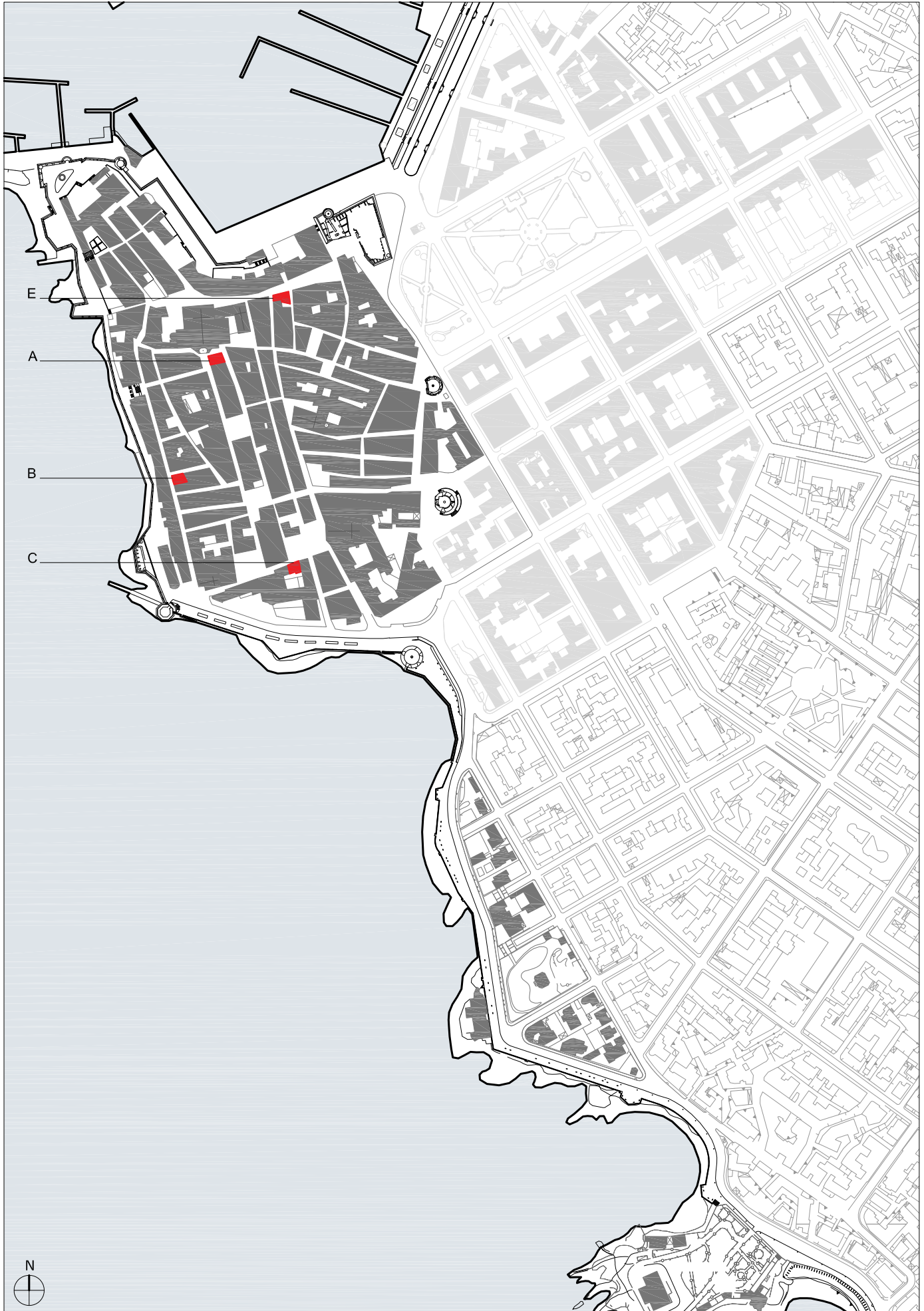



6 - CORNICI FINESTRE

INQUADRAMENTO PLANIMETRICO

PIANO PARTICOLAREGGIATO DEL CENTRO DI ANTICA E PRIMA FORMAZIONE DI ALGHERO E FERTILIA





6 - CORNICI FINESTRE

INQUADRAMENTO PLANIMETRICO

PIANO PARTICOLAREGGIATO DEL CENTRO DI ANTICA E PRIMA FORMAZIONE DI ALGHERO E FERTILIA



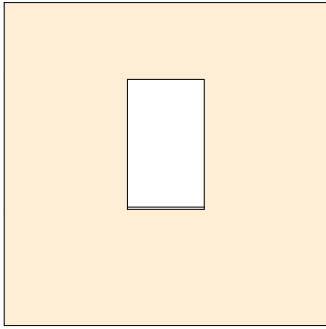

UE 2201



TIPO 6A)
SENZA CORNICI EVIDENTI

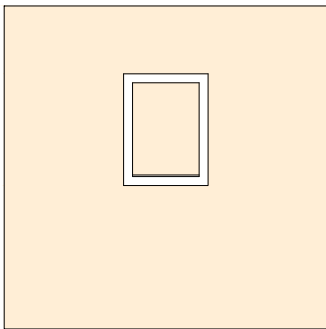

UE 2505



TIPO 6B) NON IN RILIEVO CON FINITURA
SUPERFICIALE AD INTONACO
O SOLA TINTEGGIATURA

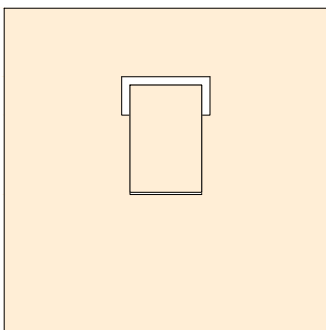

UE 5716



TIPO 6C)
IN RILIEVO CON CORONAMENTO SEMPLICE
O MODANATO

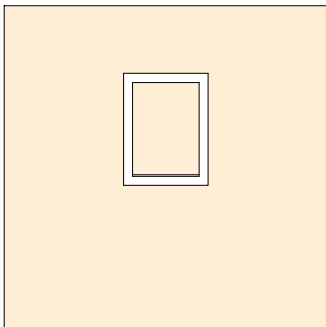

UE 8316



TIPO 6D)
IN RILIEVO, SEMPLICE CON FINITURA
SUPERFICIALE AD INTONACO E
TINTEGGIATURA

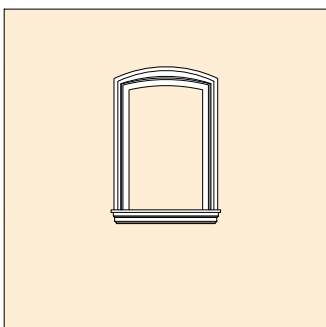

UE 4001



TIPO 6E)
IN RILIEVO MODANATA CON FINITURA
SUPERFICIALE AD INTONACO E
TINTEGGIATURA

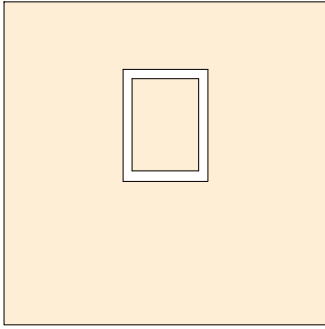

UE 10603



TIPO 6F)
SEMPLICE IN TRACHITE



7 - INFISSI FINESTRE



7 - INFISSI FINESTRE

INQUADRAMENTO PLANIMETRICO

PIANO PARTICOLAREGGIATO DEL CENTRO DI ANTICA E PRIMA FORMAZIONE DI ALGHERO E FERTILIA

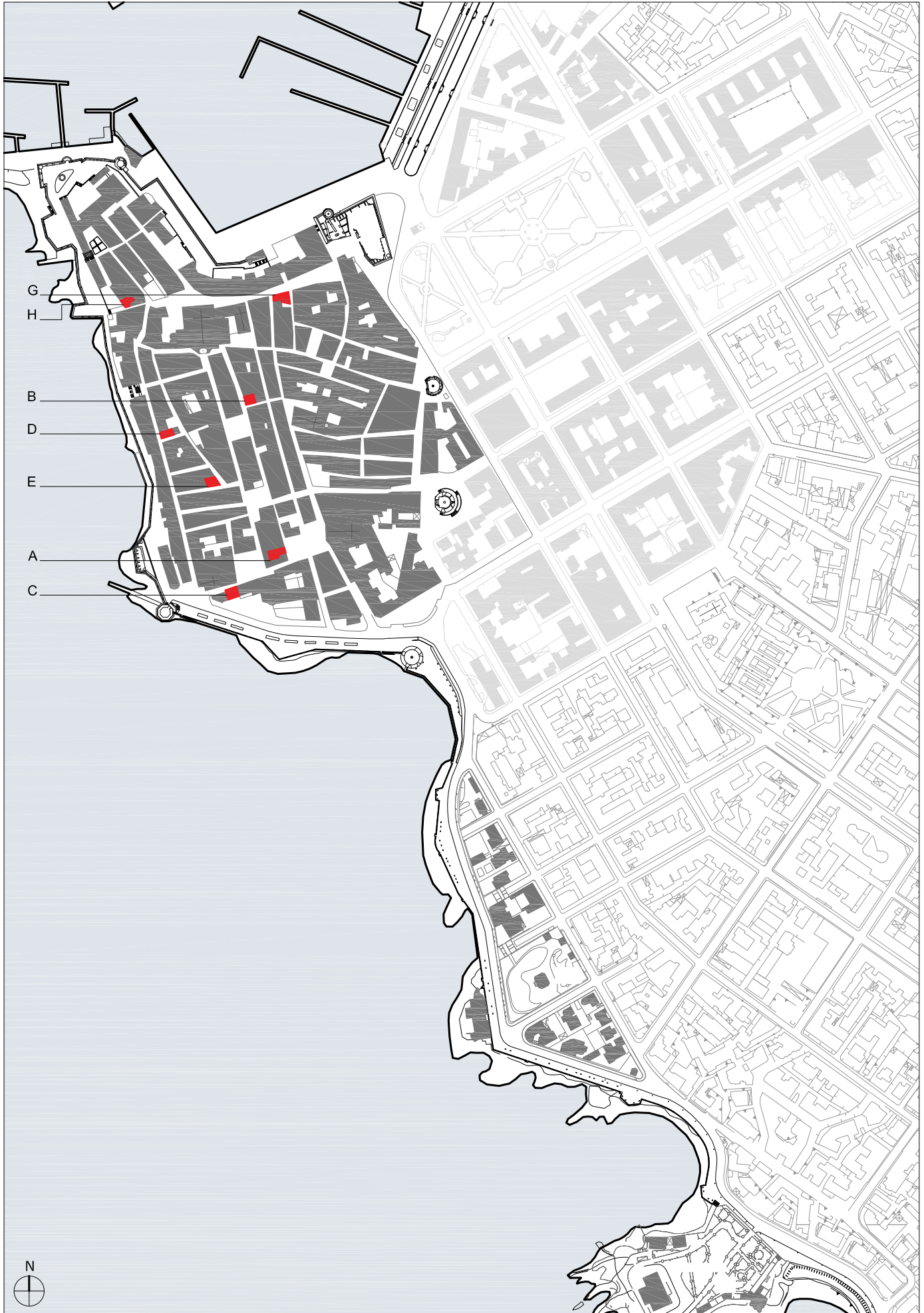



7 - INFISSI FINESTRE

INQUADRAMENTO PLANIMETRICO

PIANO PARTICOLAREGGIATO DEL CENTRO DI ANTICA E PRIMA FORMAZIONE DI ALGHERO E FERTILIA





7 - INFISSI FINESTRE

INQUADRAMENTO PLANIMETRICO



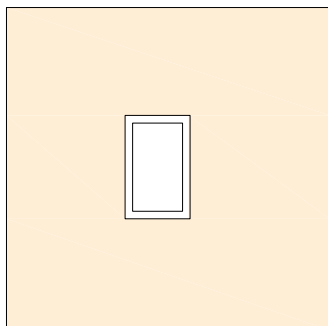

UE 5305



TIPO 7A)
AD ANTA UNICA

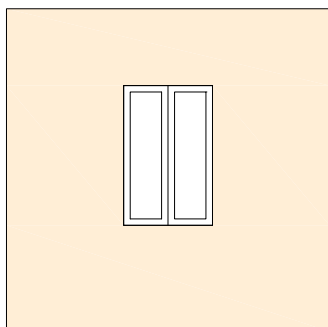

UE 2308



TIPO 7B)
A DUE ANTE CON UNA SPECCHIATURA
PER BATTENTE

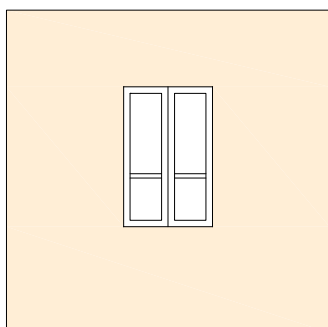

UE 5710



TIPO 7C)
A DUE ANTE CON DUE SPECCHIATURE
DISUGUALI PER BATTENTE

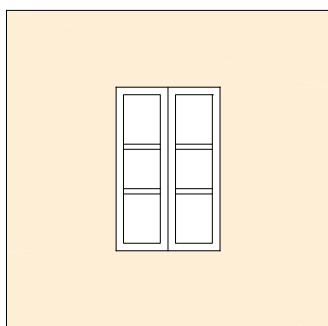

UE 2008



TIPO 7D)
A DUE ANTE CON TRE SPECCHIATURE
UGUALI PER BATTENTE

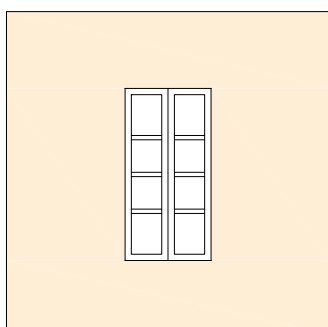

UE 2502



TIPO 7E)
A DUE ANTE CON QUATTRO SPECCHIATURE
UGUALI PER BATTENTE

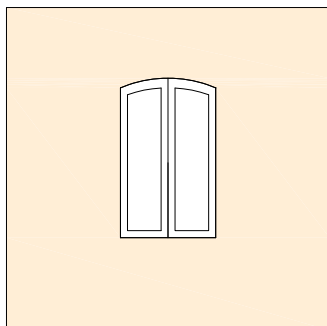

UE 8316



TIPO 7F)
CON ARCO RIBASSATO E DUE ANTE CON UNA
SPECCHIATURA PER BATTENTE

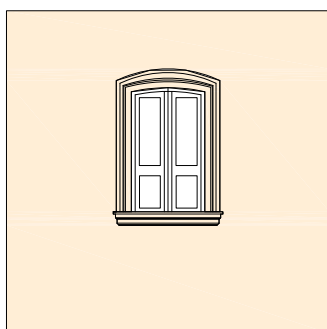

UE 4001



TIPO 7G)
CON ARCO RIBASSATO E DUE ANTE CON DUE
SPECCHIATURE PER BATTENTE

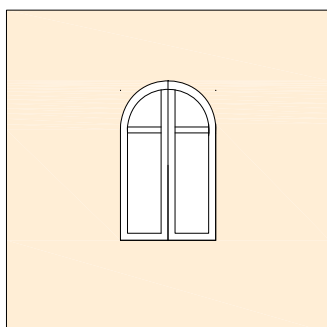

UE 509



TIPO 7H)
CON ARCO A TUTTO SESTO E DUE ANTE CON
DUE SPECCHIATURE PER BATTENTE

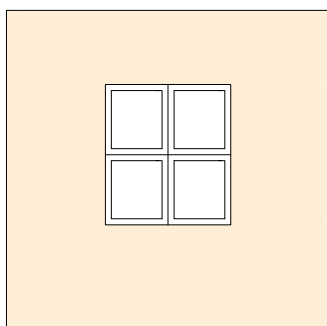

UE 11102



TIPO 7 I)
A DUE ANTE CON DUE SPECCHIATURE
UGUALI PER BATTENTE

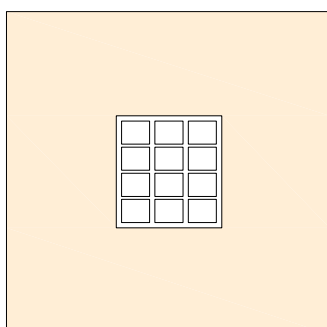

UE 11101



TIPO 7 L)
A TRE ANTE CON QUATTRO SPECCHIATURE
PER BATTENTE



8 - PERSIANE



8 - PERSIANE

INQUADRAMENTO PLANIMETRICO





8 - PERSIANE

INQUADRAMENTO PLANIMETRICO

PIANO PARTICOLAREGGIATO DEL CENTRO DI ANTICA E PRIMA FORMAZIONE DI ALGHERO E FERTILIA

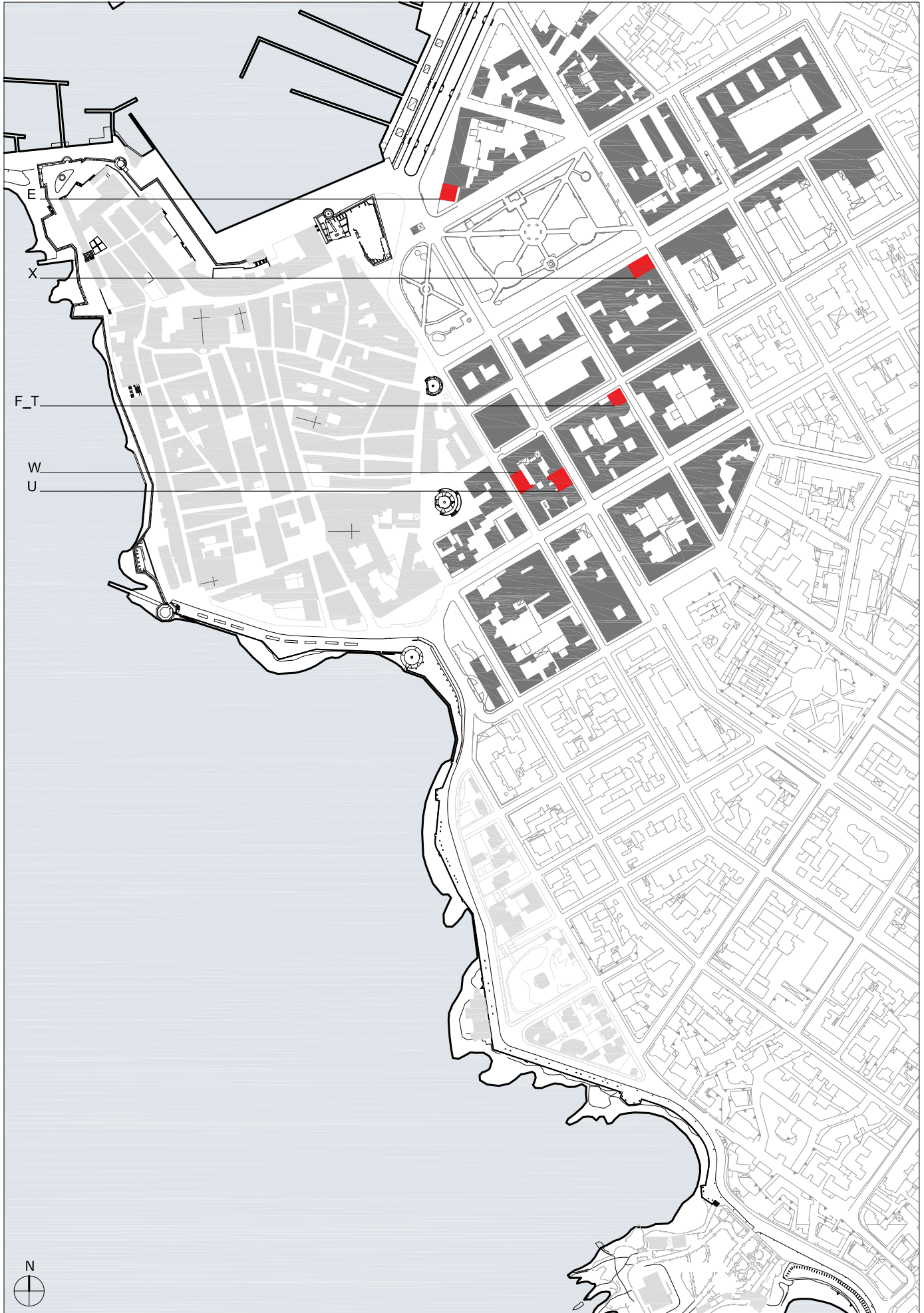



8 - PERSIANE

INQUADRAMENTO PLANIMETRICO

PIANO PARTICOLAREGGIATO DEL CENTRO DI ANTICA E PRIMA FORMAZIONE DI ALGHERO E FERTILIA



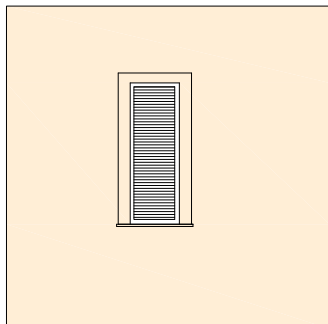

UE 2620



TIPO 8A)
UN ANTA CON APERTURA VERSO
L'ESTERNO

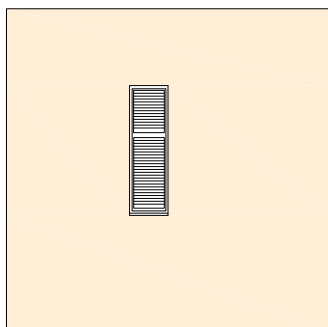

UE 507



TIPO 8B)
UN ANTA CON APERTURA VASISTAS

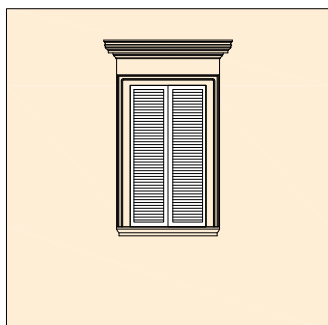

UE 1201



TIPO 8C)
DUE ANTE CON APERTURA VERSO L'ESTERNO

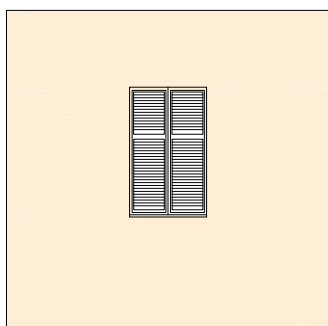

UE 1901



TIPO 8D)
DUE ANTE CON APERTURA VASISTAS

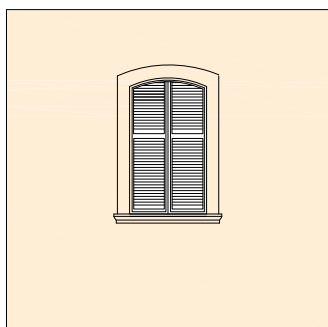

UE 7009



TIPO 8E)
AD ARCO RIBASSATO CON DUE ANTE E
APERTURA VERSO L'ESTERNO

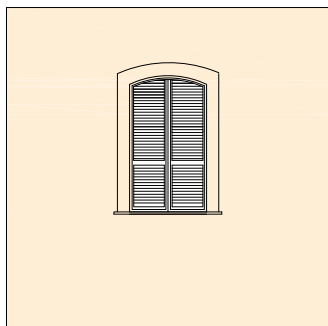

UE 8401



TIPO 8F)
AD ARCO RIBASSATO CON DUE ANTE E
APERTURA A VASISTAS

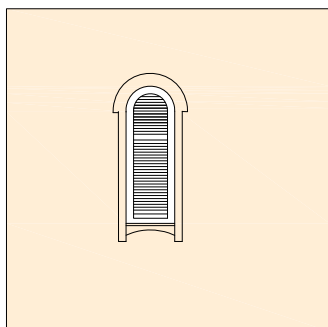

UE 6102



TIPO 8G)
AD ARCO A TUTTO SESTO CON UN' ANTA
A VASISTAS

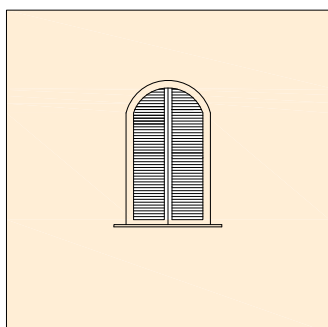

UE 509



TIPO 8H)
AD ARCO A TUTTO SESTO CON DUE ANTE E
APERTURA VERSO L'ESTERNO

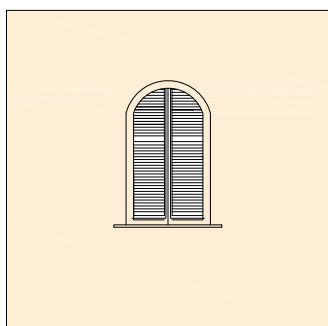

UE 5703



TIPO 8I)
AD ARCO A TUTTO SESTO CON DUE ANTE E
APERTURA A VASISTAS

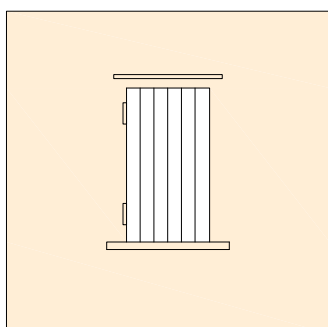

UE 1516



TIPO 8L)
PORTELLONE A UN'ANTA

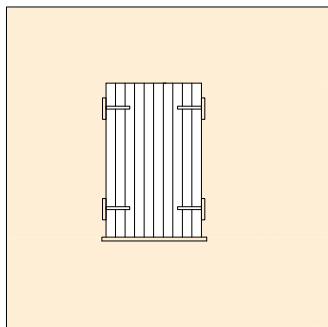

UE 508



TIPO 8M)
PORTELLONE A DUE ANTE

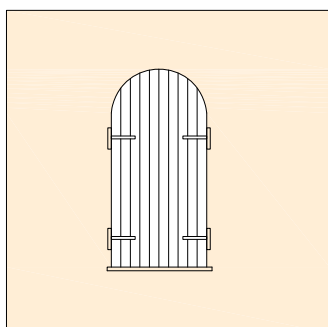

UE 508



TIPO 8N)
PORTELLONE AD ARCO A TUTTO SESTO CON
DUE ANTE

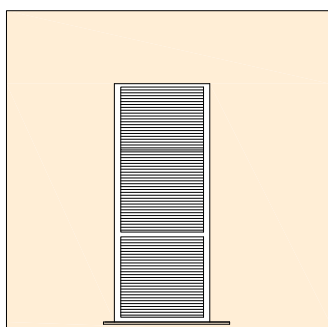

UE 1518



TIPO 8O)
A UN ANTA CON APERTURE VERSO L'ESTERNO
O VASISTAS

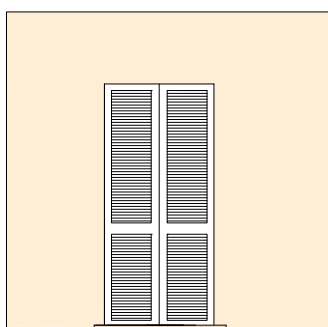

UE 103



TIPO 8P)
A DUE ANTE CON APERTURA VERSO
L'ESTERNO

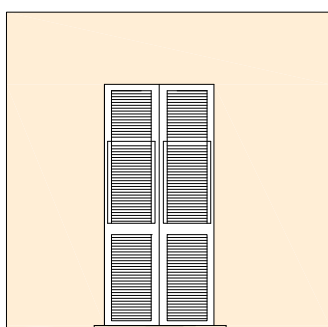

UE 3101



TIPO 8Q)
A DUE ANTE CON APERTURA A VASISTAS

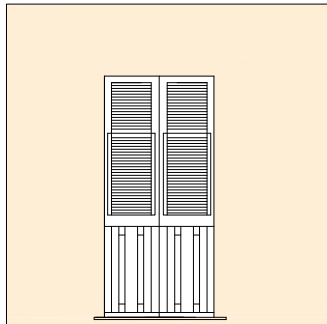

UE 1109



TIPO 8R)
A DUE ANTE CON PORTELLETTA

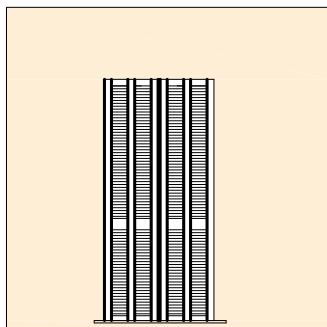

UE 301



TIPO 8S)
A DUE ANTE A LIBRO

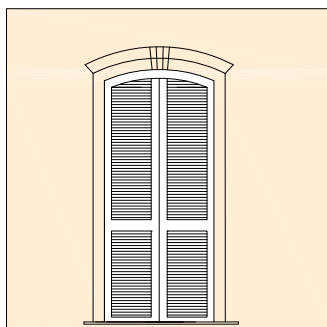

UE 8401



TIPO 8T)
A DUE ANTE CON APERTURA VERSO L'ESTERNO
AD ARCO RIBASSATO

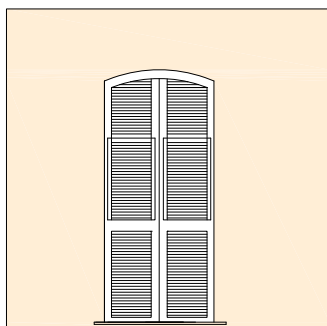

UE 8503



TIPO 8U)
A DUE ANTE CON APERTURA A VASISTAS
AD ARCO RIBASSATO

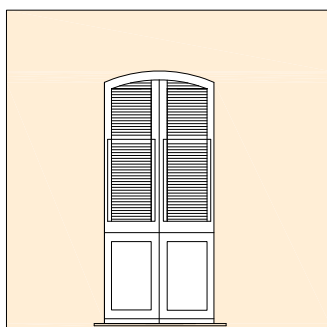

UE 4502



TIPO 8V)
A DUE ANTE CON APERTURA VERSO L'ESTERNO
O VASISTAS, AD ARCO RIBASSATO CON
PORTELLETTA

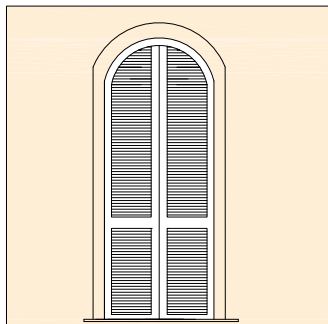

UE 8509



TIPO 8W)
A DUE ANTE CON APERTURA VERSO L'ESTERNO
AD ARCO A TUTTO SESTO

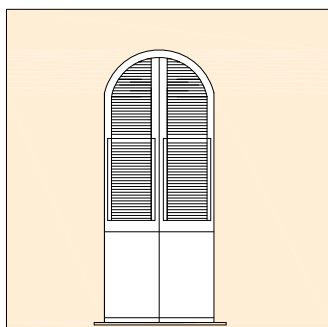

UE 7901



TIPO 8X)
A DUE ANTE CON APERTURA A VASISTAS
AD ARCO A TUTTO SESTO

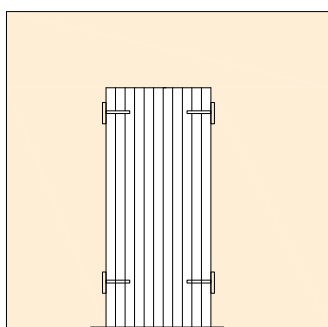

UE 1410



TIPO 8Y)
PORTELLONE A DUE ANTE

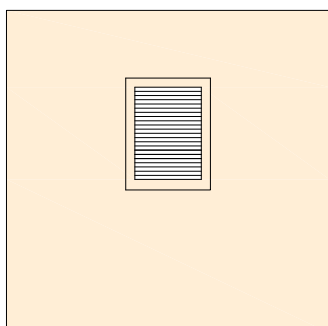

UE 10701



TIPO 8Z)
AVVOLGIBILE

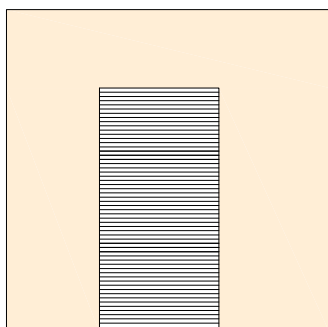

UE 10603



TIPO 8J)
AVVOLGIBILE



9 - BALCONI



9 - BALCONI

INQUADRAMENTO PLANIMETRICO

PIANO PARTICOLAREGGIATO DEL CENTRO DI ANTICA E PRIMA FORMAZIONE DI ALGHERO E FERTILIA





9 - BALCONI

INQUADRAMENTO PLANIMETRICO

PIANO PARTICOLAREGGIATO DEL CENTRO DI ANTICA E PRIMA FORMAZIONE DI ALGHERO E FERTILIA

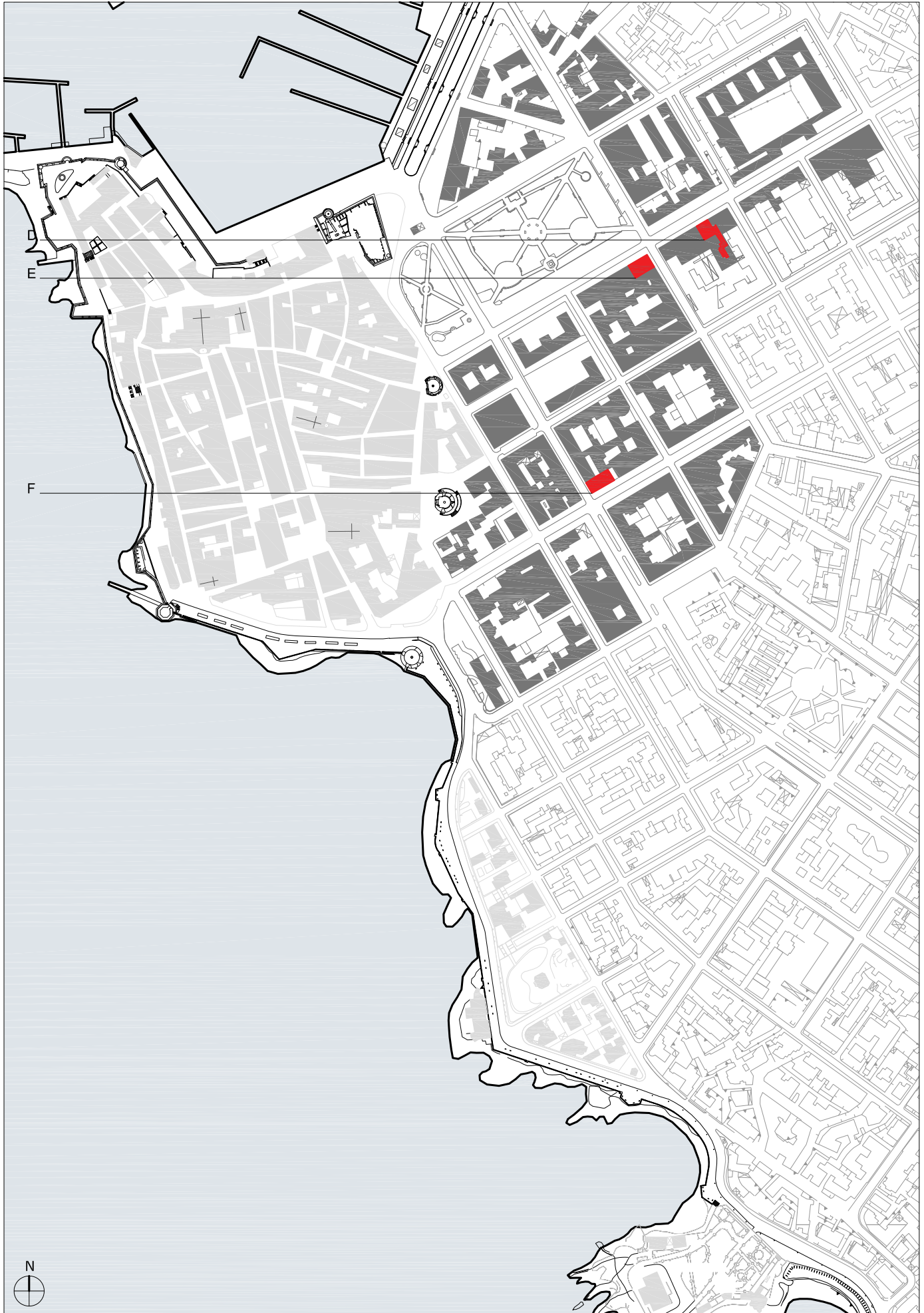



9 - BALCONI

INQUADRAMENTO PLANIMETRICO

PIANO PARTICOLAREGGIATO DEL CENTRO DI ANTICA E PRIMA FORMAZIONE DI ALGHERO E FERTILIA



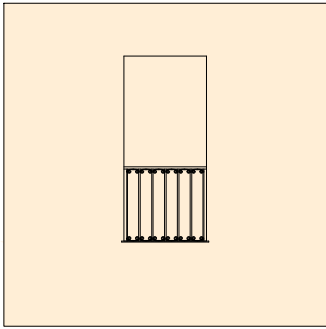

UE 4604



TIPO 9A)
FILO PARETE CON SOGLIA
IN PIETRA O MARMO

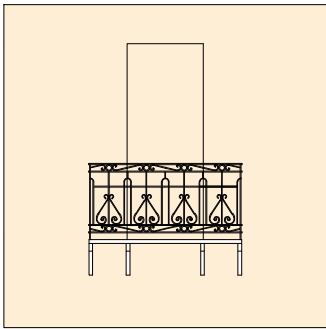

UE 103



TIPO 9B)
PIANO IN LEGNO SU MENSOLE
IN FERRO

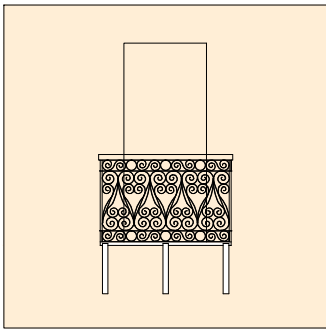

UE 5501



TIPO 9C)
PIANO IN MARMO SU MENSOLE
IN FERRO

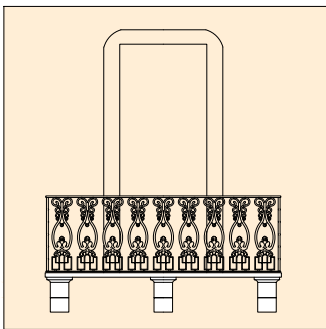

UE 7803



TIPO 9D)
PIANO IN MARMO SU MENSOLE
IN PIETRA

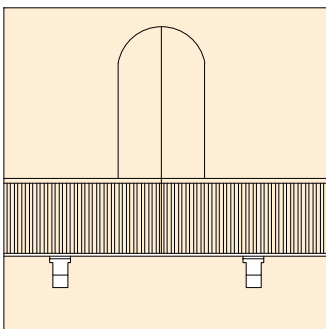

UE 7901



TIPO 9E)
PIANO E MENSOLE IN MARMO

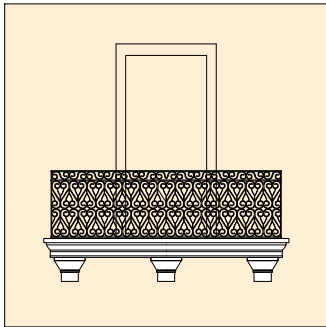

UE 8406



TIPO 9F)
PIANO IN LATERO CEMENTO
SU MENSOLE IN MARMO

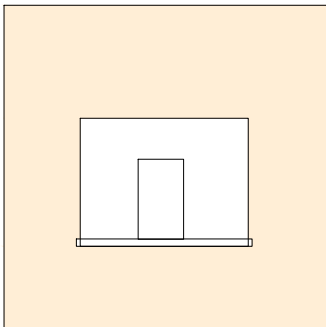

UE 10701



TIPO 9G)
ARRETRATO RISPETTO AL FILO FACCIATA



10 - RINGHIERE



10 - RINGHIERE

INQUADRAMENTO PLANIMETRICO

PIANO PARTICOLAREGGIATO DEL CENTRO DI ANTICA E PRIMA FORMAZIONE DI ALGHERO E FERTILIA





10 - RINGHIERE

INQUADRAMENTO PLANIMETRICO

PIANO PARTICOLAREGGIATO DEL CENTRO DI ANTICA E PRIMA FORMAZIONE DI ALGHERO E FERTILIA

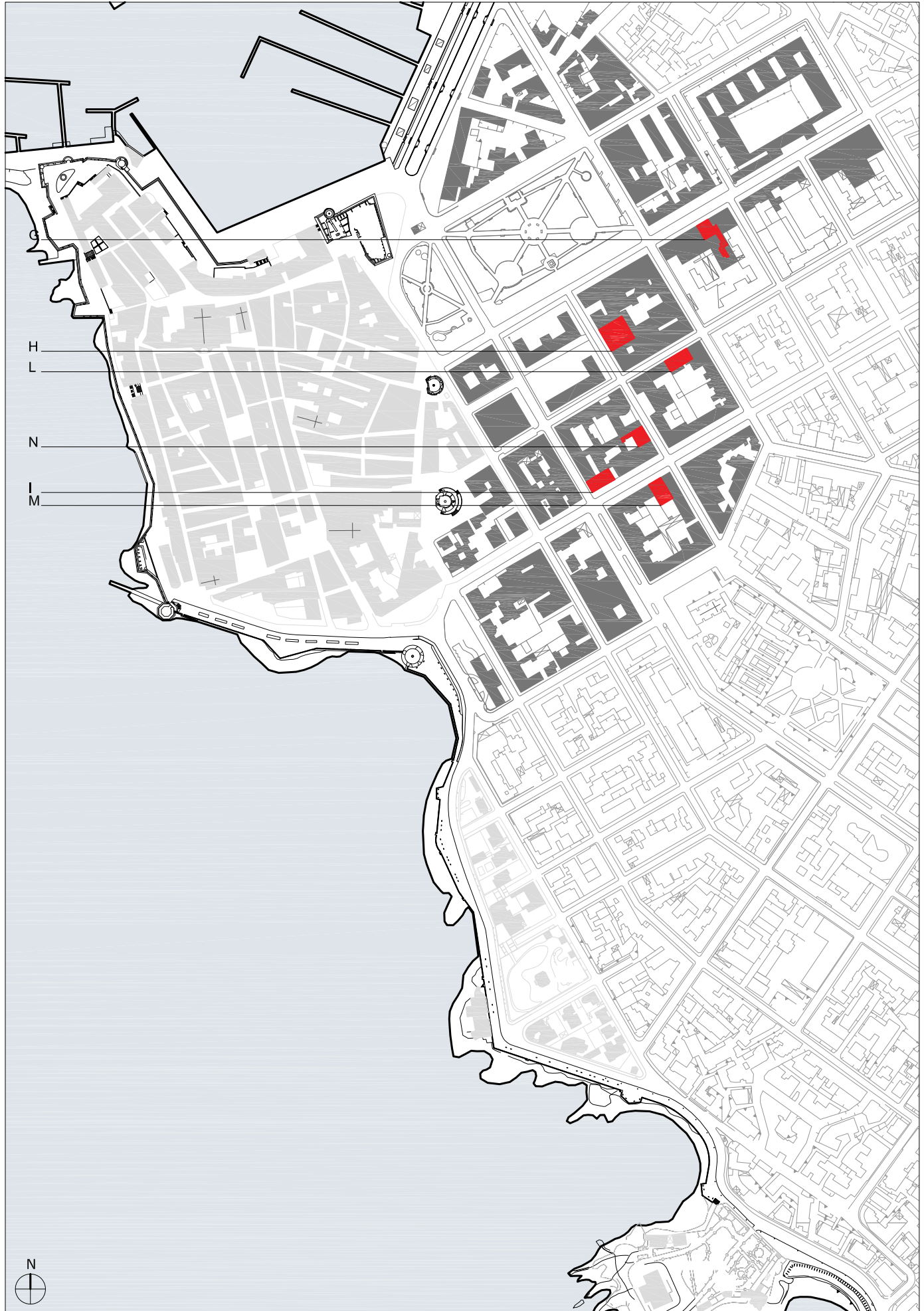



10 - RINGHIERE

INQUADRAMENTO PLANIMETRICO

PIANO PARTICOLAREGGIATO DEL CENTRO DI ANTICA E PRIMA FORMAZIONE DI ALGHERO E FERTILIA



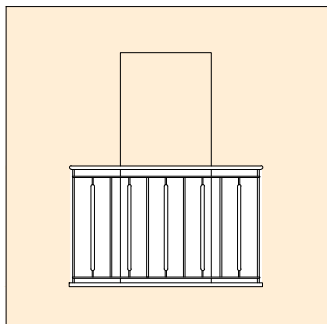

UE 3105

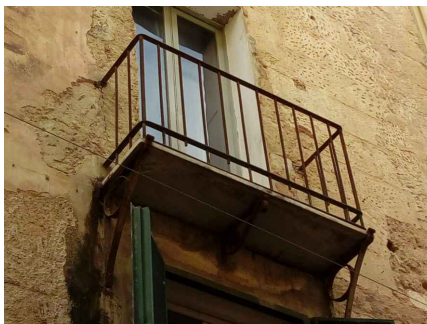

TIPO 10A)
CON ELEMENTI RETTILINEI
SEMPLICI O BORCHIE

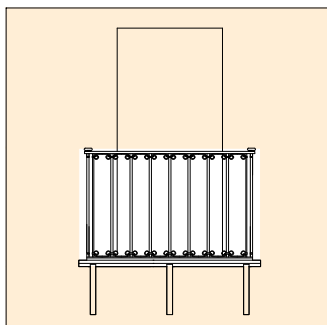

UE 4604



TIPO 10B)
CON ELEMENTI VERTICALI
E VOLUTE

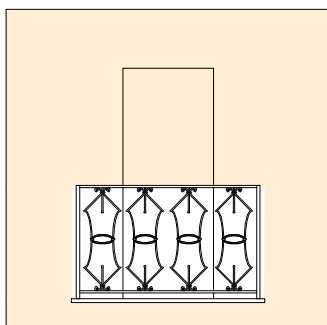

UE 4811



TIPO 10C)
CON ELEMENTI RETTILINEI E CURVI

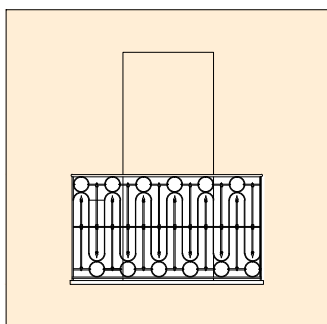

UE 2203



TIPO 10D)
CON ELEMENTI RETTILINEI E
GEOMETRICI

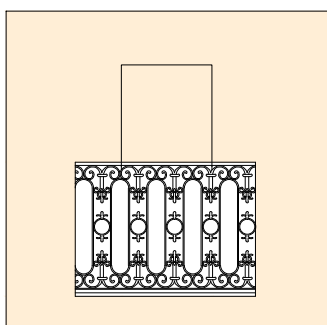

UE 3104



TIPO 10E)
CON ELEMENTI RETTILINEI,
VOLUTE E GIGLIATI

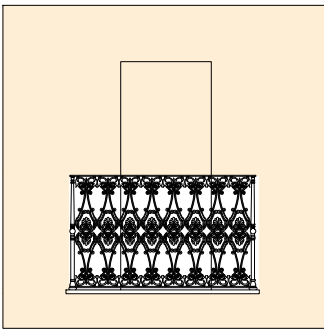

UE 3303



TIPO 10F)
CON ELEMENTI FLOREALI

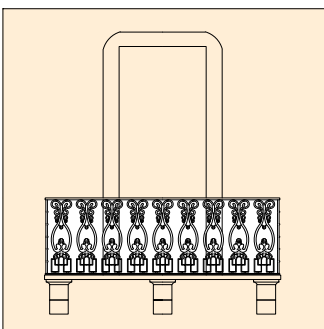

UE 7803



TIPO 10G)
CON ELEMENTI DECORATI DI
GHISA STAMPATA

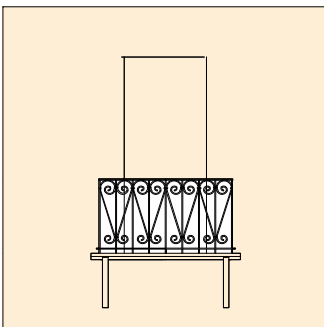

UE 7909



TIPO 10H)
A VOLUTE VERTICALI SEMPLICI

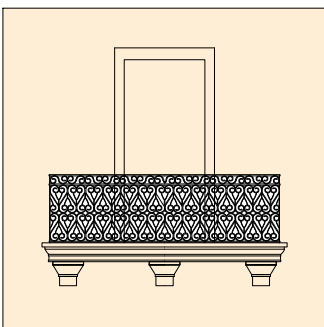

UE 8406



TIPO 10I)
A VOLUTE RICCAMENTE DECORATE

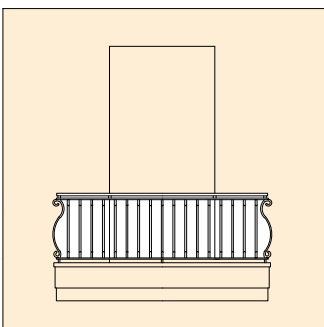

UE 8316



TIPO 10L)
CON ELEMENTI CURVILINEI VERTICALI

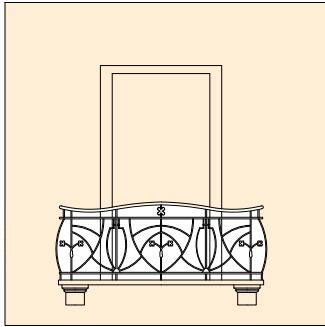

UE 8816



TIPO 10M)
CON ELEMENTI CURVILINEI LIBERTY

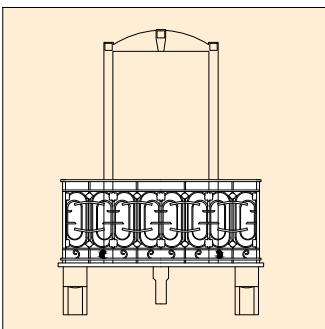

UE 8402



TIPO 10 N)
CON DECORI LIBERTY

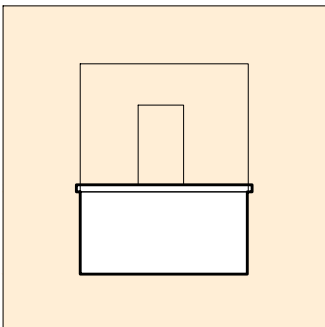

UE 10701



TIPO 10 O)
IN MURATURA



11 - CORNICIONI DI GRONDA



11 - CORNICIONI DI GRONDA

INQUADRAMENTO PLANIMETRICO

PIANO PARTICOLAREGGIATO DEL CENTRO DI ANTICA E PRIMA FORMAZIONE DI ALGHERO E FERTILIA





11 - CORNICIONI DI GRONDA

INQUADRAMENTO PLANIMETRICO

PIANO PARTICOLAREGGIATO DEL CENTRO DI ANTICA E PRIMA FORMAZIONE DI ALGHERO E FERTILIA





11 - CORNICIONI DI GRONDA

INQUADRAMENTO PLANIMETRICO

PIANO PARTICOLAREGGIATO DEL CENTRO DI ANTICA E PRIMA FORMAZIONE DI ALGHERO E FERTILIA



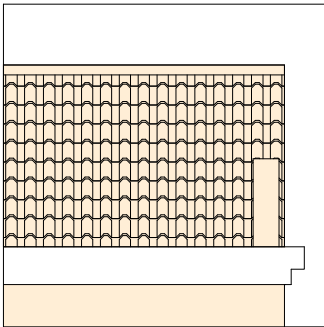

UE 2111



TIPO 11A)
A FASCIA SEMPLICE DRITTA

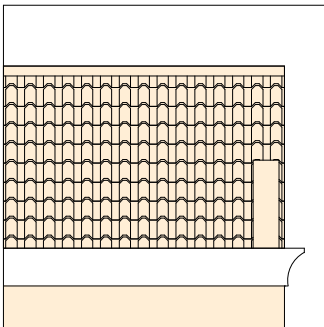

UE 8501



TIPO 11B)
A FASCIA SEMPLICE CURVILINEA

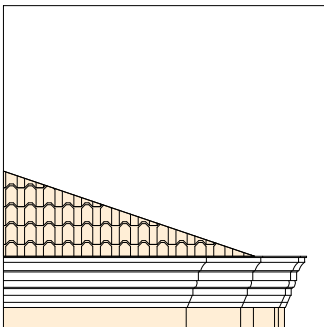

UE 3701



TIPO 11C)
A FASCIA MODANATA

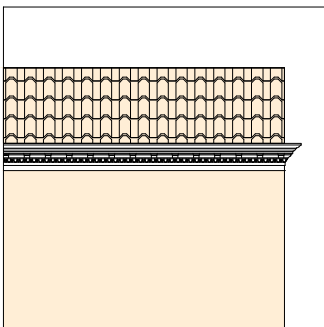

UE 3102



TIPO 11D)
A FASCIA MODANATA ED ORNATA

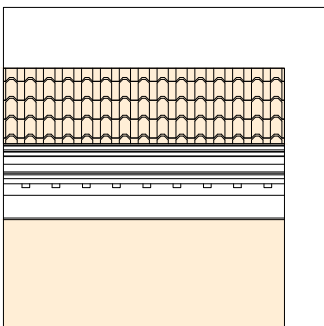

UE 4801



TIPO 11E)
A FASCIA MODANATA ED ORNATA CON
DENTELLI

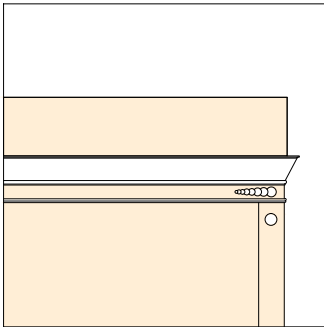

UE 7907



TIPO 11F)
AGGETTANTE SU FASCE DECO'

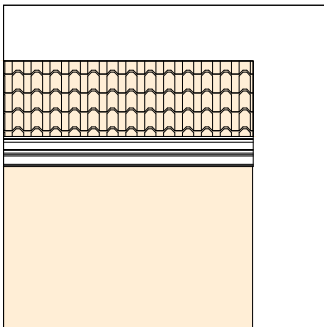

UE 8502



TIPO 11G)
AGGETTANTE CON FASCIA MODANATA

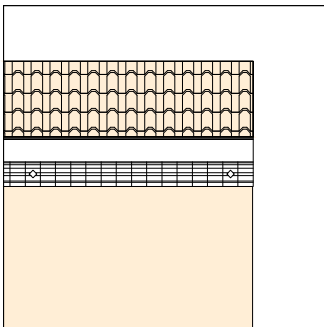

UE 8312



TIPO 11H)
AGGETTANTE IN CONCI DI
PIETRA DECORATI

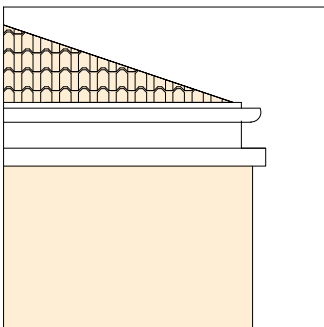

UE 10701

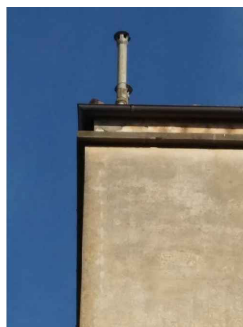

TIPO 11I)
A DOPPIA FASCIA IN TRACHITE



ELEMENTI DA PRESERVARE



ELEMENTI DA PRESERVARE

INQUADRAMENTO PLANIMETRICO

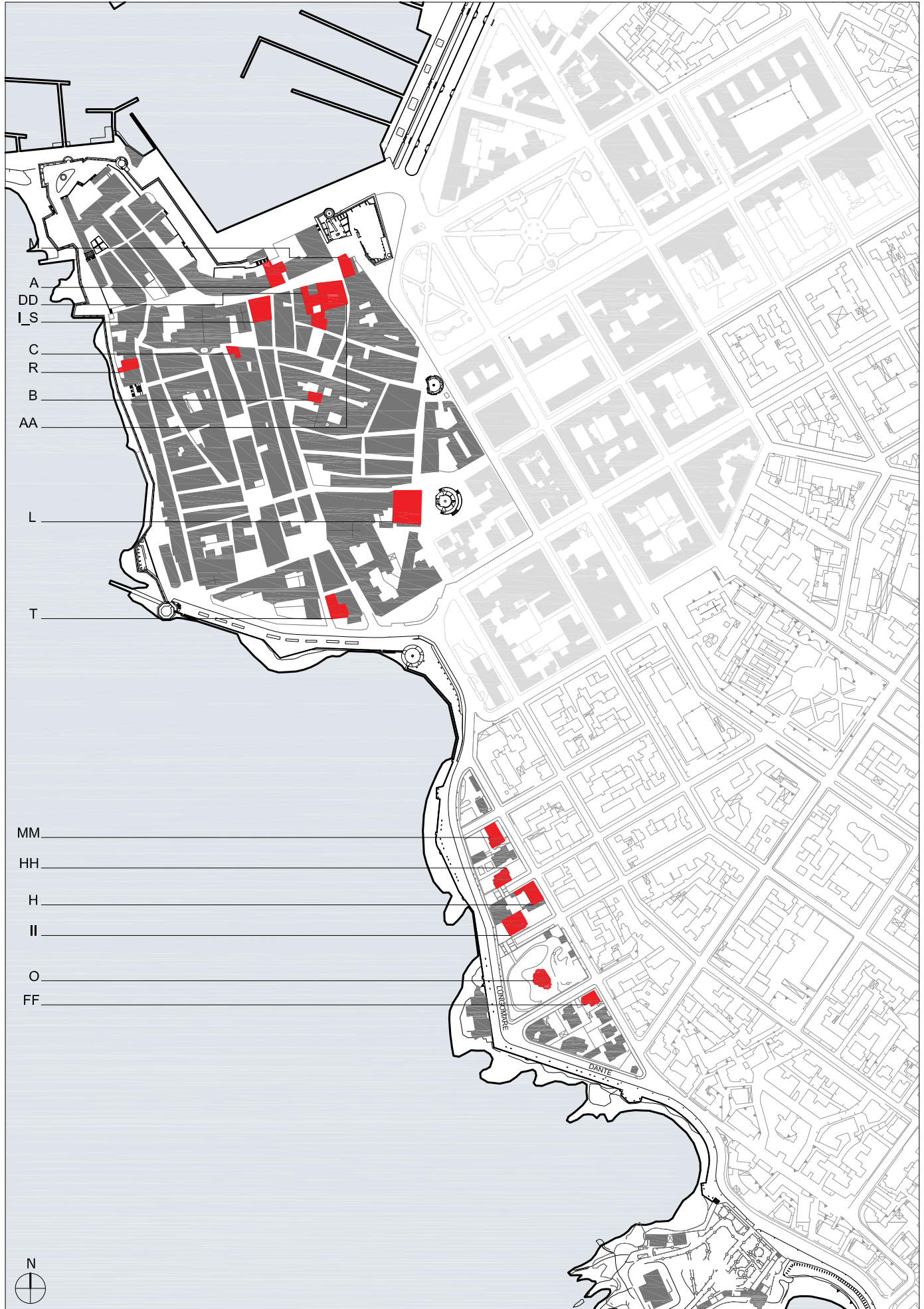



ELEMENTI DA PRESERVARE

INQUADRAMENTO PLANIMETRICO

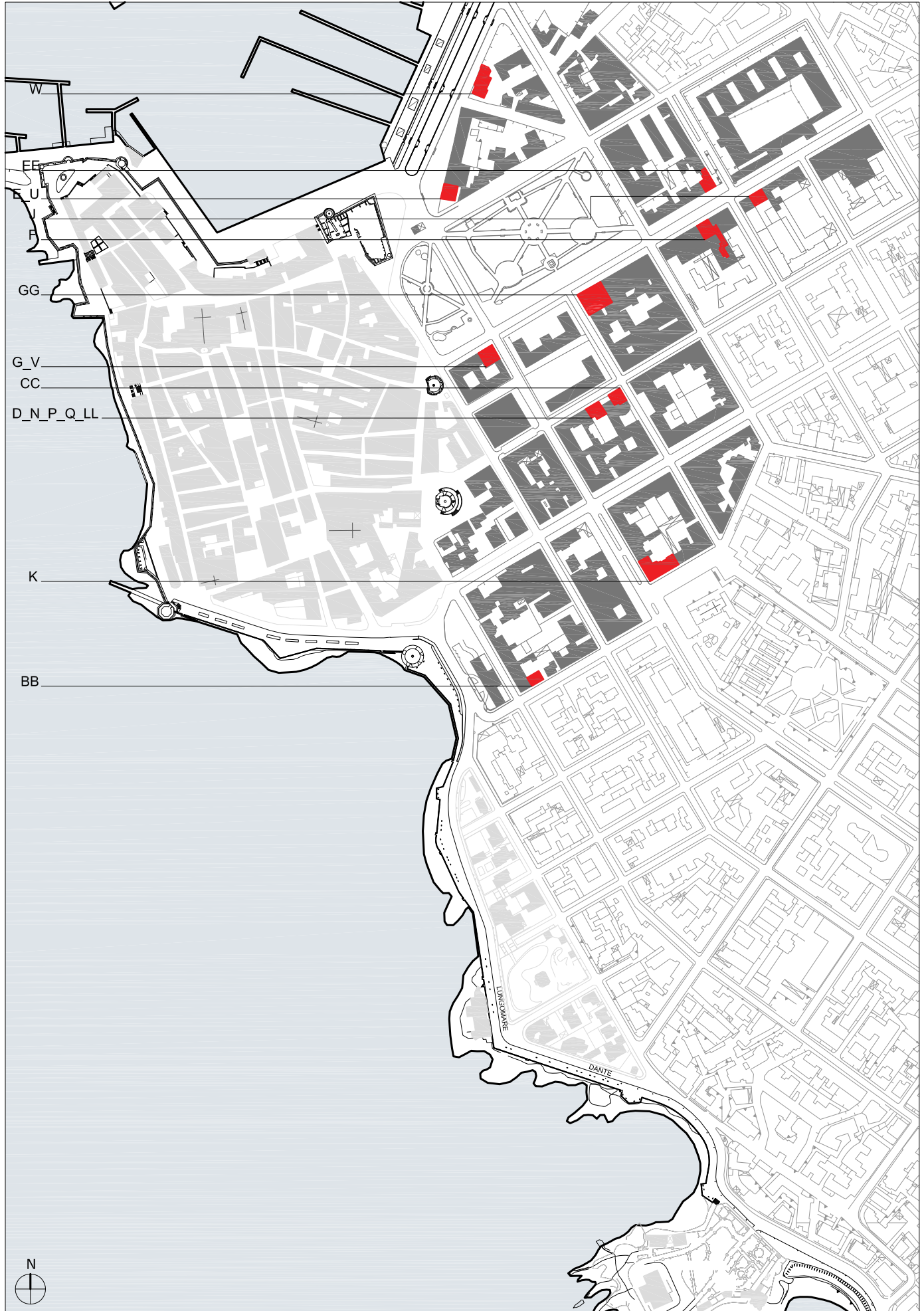



ELEMENTI DA PRESERVARE

INQUADRAMENTO PLANIMETRICO



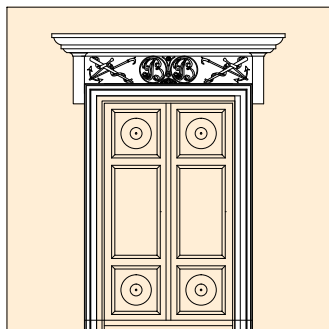

UE 1110



A)
CORNICE DEL PORTONE MODANATA CON
TRABEAZIONE SOSTENUTA DA MENSOLE

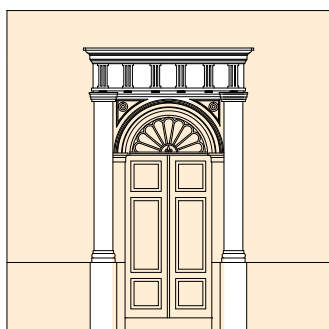

UE 4809



B)
CORNICE DEL PORTONE ORNATA CON
CORONAMENTO ARCHITRAVATO,
CAPITELLI E ZOCCOLO

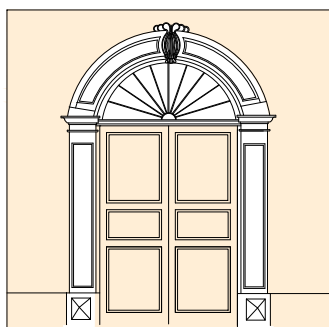

UE 2315



C)
CORNICE DEL PORTONE CON ARCHIVOLTO,
CAPITELLI E ZOCCOLI

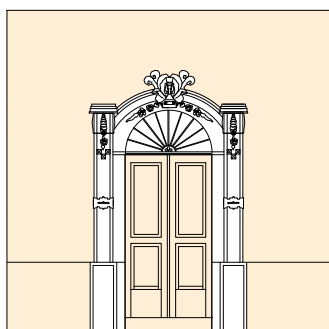

UE 8412



D)
CORNICE DEL PORTONE RICCAMENTE DECORATA
CON STUCCHI FLOREALI E VISO MASCHILE

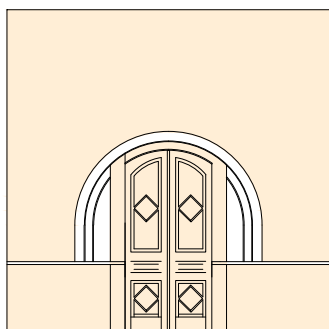

UE 7009



E)
CORNICE DEL PORTONE MODANATA CON
FINESTRE LATERALI E DECORI DIPINTI

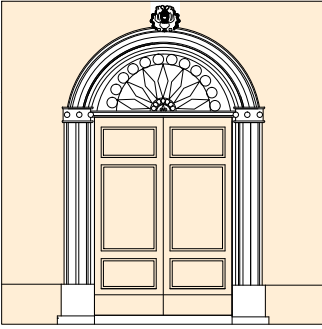

UE 7803



F)
CORNICE DEL PORTONE MODANATA CON
IMPOSTA DECORATA DELL' ARCO E FREGIO
IN CHIAVE

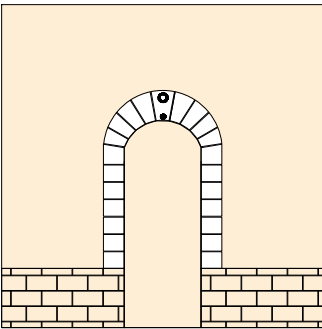

UE 8101



G)
CORNICE DEL PORTONE CON CONCI BUGNATI
IN PIETRE E CHIAVE DECORATA

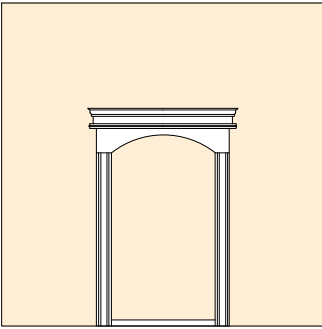

UE 6301



H)
CORNICE DEL PORTONE MODANATA,
TRABEAZIONE E ARCO RIBASSATO

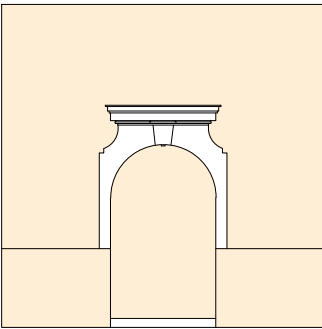

UE 1001



I)
CORNICE DEL PORTONE CON TRABEAZIONE E
CONCI DI CHIAVE

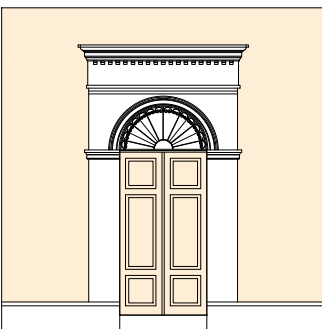

UE 7704



J)
CORNICE DEL PORTONE A FASCIA CON
TRABEAZIONE MODANATA E DENTELLATA,
CON ARCO E FASCE MODANATE

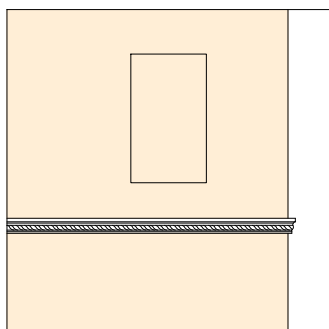

UE 8412



P)
CORNICE MARCAPIANO MODANATA
SEMPLICE CON DECORO A CORDA

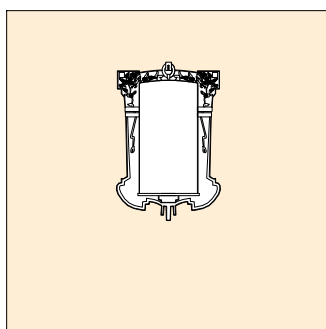
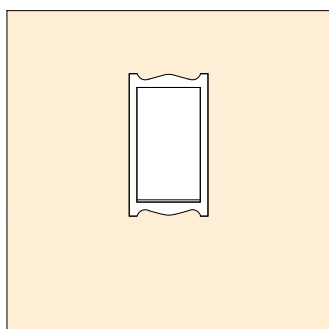

UE 8412

Q)
CORNICE DELLA FINESTRA SAGOMATA

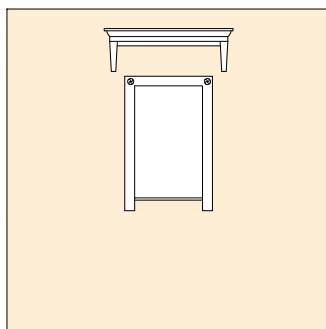
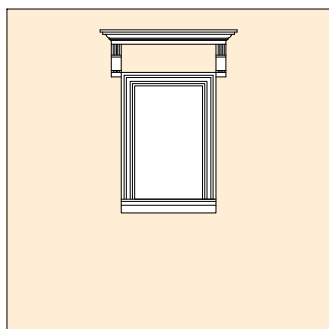

UE 1409

R)
CORNICE DELLA FINESTRA MODANATA E
CON TRABEAZIONE SOSTENUTA DA MENSOLE

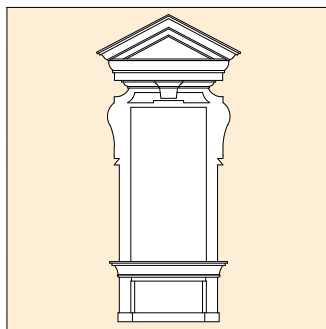
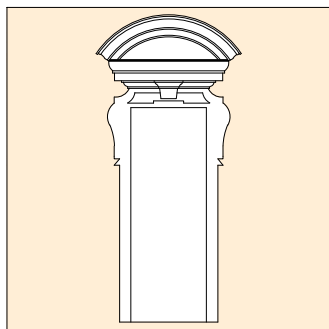

UE 1001

S)
CORNICE DELLA FINESTRA ARCHITRAVATA CON
TIMPANO CIRCOLARE O TRIANGOLARE

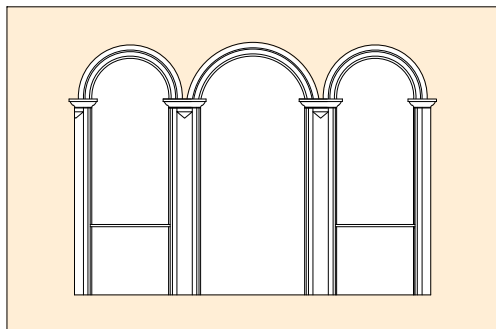

UE 5902

T)
CORNICE DELLA FINESTRA POLIFORA
ARCHIVOLTATA CON CAPITELLI E COLONNE

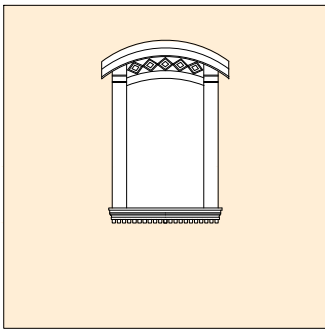

UE 7009



U)
CORNICE DELLA FINESTRA MODANATA CON
DECORO SOPRASTANTE DIPINTO

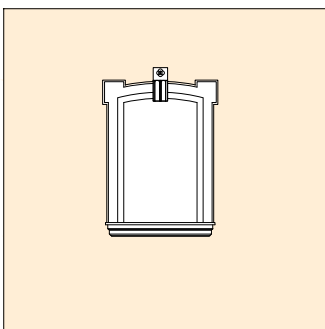

UE 8101



V)
CORNICE DELLA FINESTRA MODANATA AD ARCO
RIBASSATO CON CONCIO IN CHIAVE DECORATO

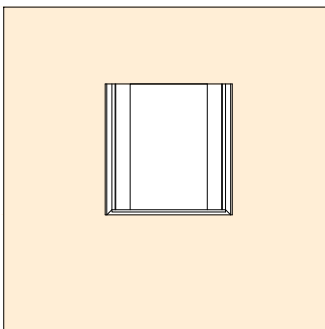

UE 6908



W)
CORNICE DELLA FINESTRA CON SGUINCI
LATERALI A SEMICOLONNA

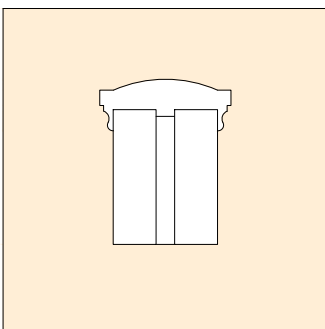

UE 10101



X)
CORNICE DI DOPPIA FINESTRA CON ARCHITRAVE
IN RILIEVO E ESTREMITA' DECORATE

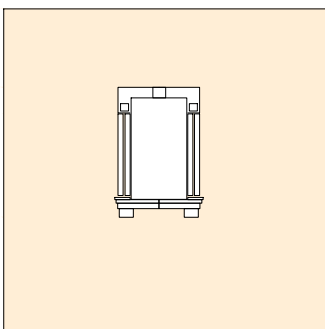

UE 10101



Y)
CORNICE DELLA FINESTRA SAGOMATA
E CON ARCHITRAVE E STIPITI IN RILIEVO

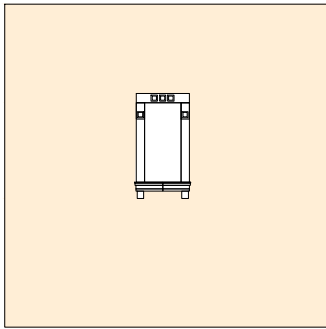

UE 10102



Z)
CORNICE DELLA FINESTRA SAGOMATA
E CON ARCHITRAVE E STIPITI IN RILIEVO

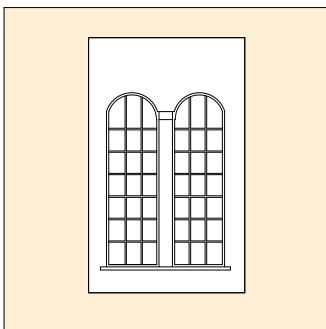

UE 4101



AA)
FINESTRA BIFORA AD ARCO A TUTTO SESTO,
MONO BATTENTE CON PIU' SPECCHIATURE

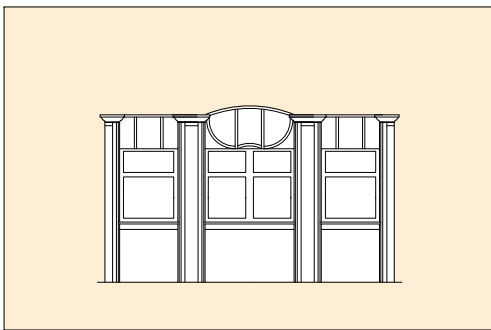

UE 9009

BB)
FINESTRA CON VETRATE DECO' A PIU' BATTENTI

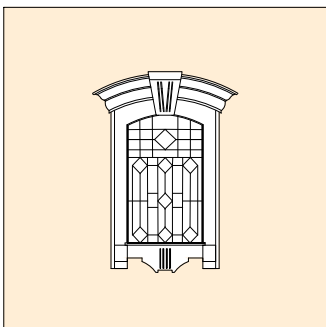

UE 8401



CC)
FINESTRA CON VETRATA POLICROMA CON
APERTURA CENTRALE MONO BATTENTE

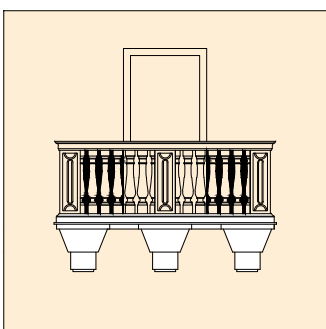

UE 4107



DD)
BALCONE CON BALAUSTR

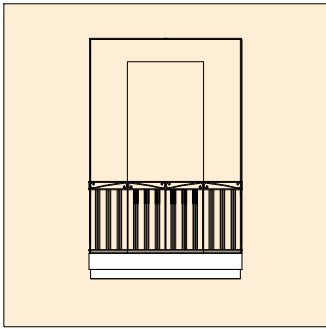

UE 7306



EE)
BALCONE SPORTO IN LATERO CEMENTO
CON INCAVO IN FACCIATA

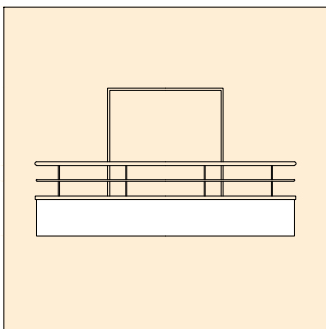

UE 6501



FF)
BALCONE CON PIANO IN
LATERO-CEMENTO SEMICIRCOLARE

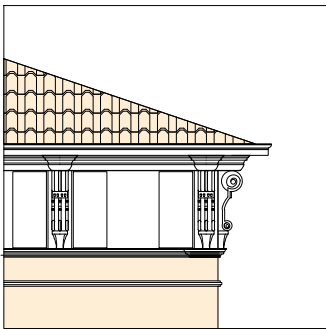

UE 7911



GG)
CORNICIONE DI GRONDA ORNATO E
AGGETTANTE SU MENSOLE

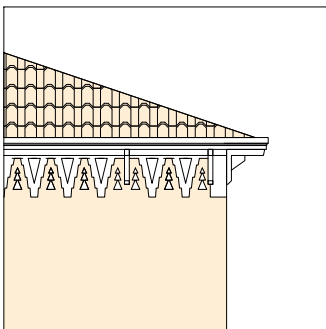

UE 6203



HH)
CORNICIONE DI GRONDA IN LATERO-CEMENTO
SU MENSOLE CON DECORI DIPINTI

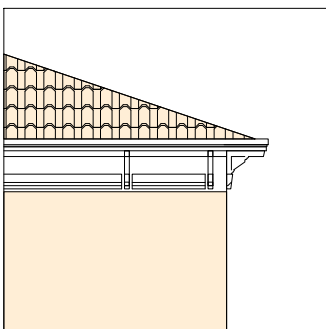

UE 6302



II)
CORNICIONE DI GRONDA IN LEGNO SU MENSOLE

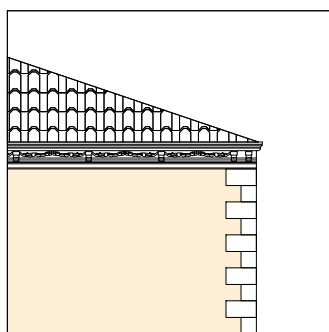

UE 8412



LL)
CORNICIONE DI GRONDA MODANATA SU
MENSOLE LEGATE DA ORNAMENTI FLOREALI

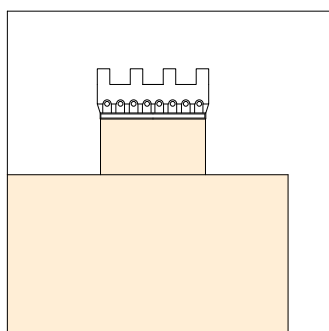

UE 6201



MM)
CORNICIONE DI GRONDA CON MERLATURE
NEOMEDIEVALI